

## Мощный светодиод ARPL-200W-BCB-7080-DW (7000mA)

### Features:

- More energy efficient than incandescent  
and most halogen lamps
- low voltage operation
- Instant light
- Long operating life
- Anti UV

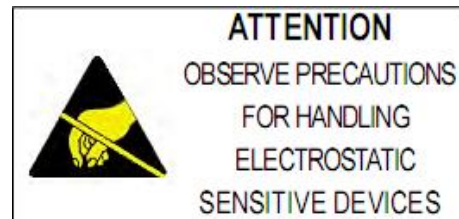

### Applications:

- Indoor lighting:  
spot light, ceiling light, bulb.....
- Architectural and landscape lighting:  
down light, wall lamp, garden light
- Roadway lighting:  
Street light, garden light, tunnel light
- Display lighting:

■ Package Dimensions

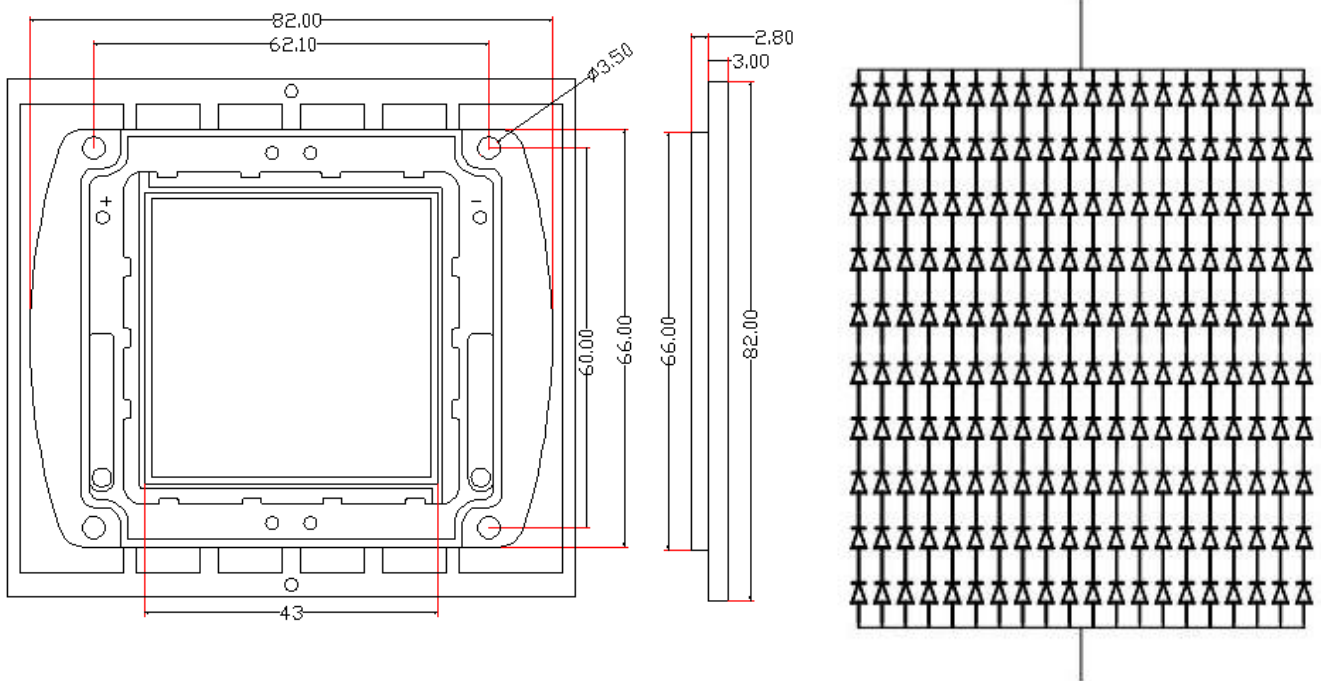

Notes: All dimensions in mm tolerance is  $\pm 0.1$ mm unless otherwise noted.

■ Radiation Diagram

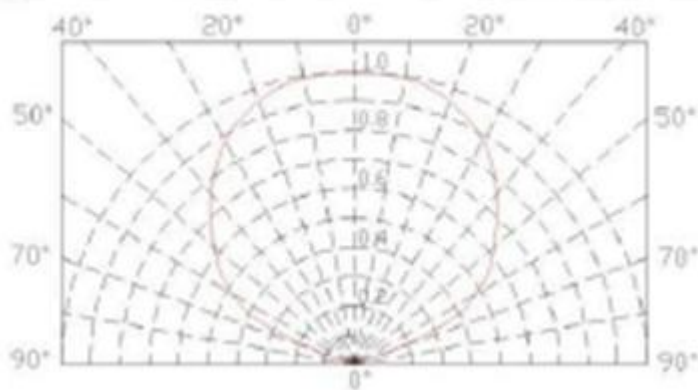

## ■ Absolute Maximum Ratings (Ta=25°C)

Parameter	Symbol	Rating	Unit
DC Forward Current	$I_F$	7000	mA
Peak pulse Current*	$I_{FP}$	10000	mA
Reverse Voltage	$V_R$	50	V
Power Dissipation	$P_D$	200	W
Operating Temperature Range	$T_{OPR}$	-30 ~ +75	°C
Storage Temperature Range	$T_{STG}$	-40 ~ +85	°C
LED Junction Temperature	$T_J$	125	°C

Notes: 1. 1/10 Duty Cycle 0.1ms Pulse Width.

## ■ Electrical/Optical Characteristics--White (At TA=25°C)

Parameter	Symbol	Conditions	Min	Avg.	Max	Units
Forward Voltage	$V_F$	$I_F=7000mA$	30.00	--	34.00	V
Thermal Resistance Junction To Board	$R\Theta_{J-B}$	$I_F=7000mA$	--	8	--	°C/W
Luminous Flux	$\Phi_v$	$I_F=7000mA$	20000		22000	lm
Color Temperature	CCT	$I_F=7000mA$	4000		4500	K
CRI	Ra	$I_F=7000mA$	60	--	--	--
Temperature Coefficient of Forward Voltage	$\Delta V_F/\Delta T$	$I_F=7000mA$	--	-2	--	mV/°C
Reverse Current	$I_R$	$V_R=50V$	--	--	10	μA
Viewing Angle <sup>[1]</sup>	$2\Theta_{1/2}$	$I_F=7000mA$	--	120	--	Deg

## ■ Color & binning

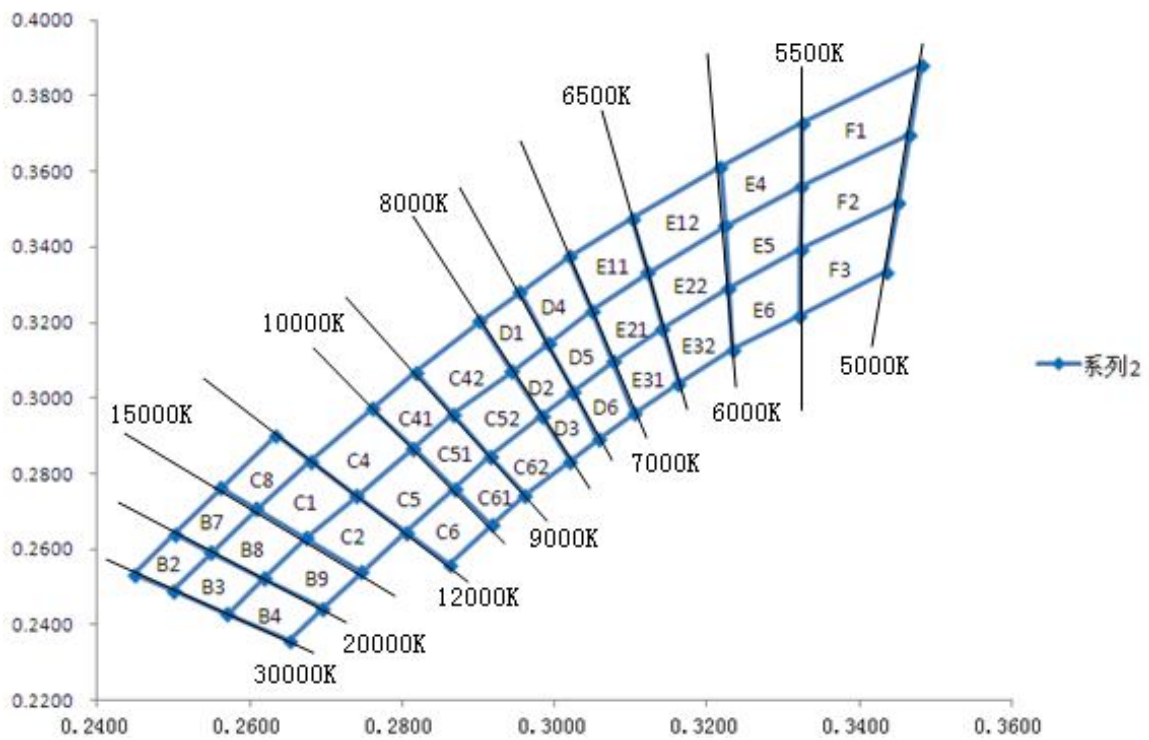
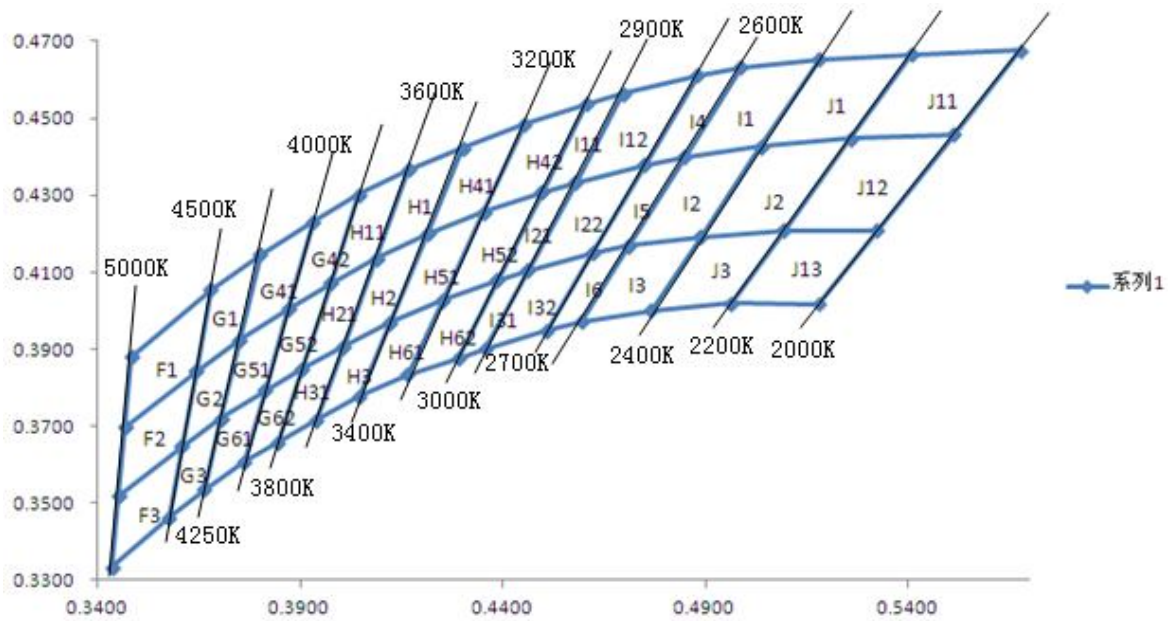

<b>J11</b>	0.5409	0.4666	<b>J12</b>	0.5258	0.4447	<b>J13</b>	0.5093	0.4209
	0.5677	0.4675		0.5513	0.4458		0.5323	0.4208
	0.5513	0.4458		0.5323	0.4208		0.5179	0.4018
	0.5258	0.4447		0.5093	0.4209		0.4963	0.4020
<b>J1</b>	0.5180	0.4653	<b>J2</b>	0.5036	0.4426	<b>J3</b>	0.4888	0.4192
	0.5409	0.4666		0.5258	0.4447		0.5093	0.4209
	0.5258	0.4447		0.5093	0.4209		0.4963	0.4020
	0.5036	0.4426		0.4888	0.4192		0.4766	0.4001
<b>I1</b>	0.4988	0.4632	<b>I2</b>	0.4849	0.4399	<b>I3</b>	0.4711	0.4169
	0.5180	0.4653		0.5036	0.4426		0.4888	0.4192
	0.5036	0.4426		0.4888	0.4192		0.4766	0.4001
	0.4849	0.4399		0.4711	0.4169		0.4593	0.3972
<b>I4</b>	0.4880	0.4611	<b>I5</b>	0.4750	0.4379	<b>I6</b>	0.4622	0.4150
	0.4988	0.4632		0.4849	0.4399		0.4711	0.4169
	0.4849	0.4399		0.4711	0.4169		0.4593	0.3972
	0.4750	0.4379		0.4622	0.4150		0.4509	0.3948
<b>I12</b>	0.4697	0.4563	<b>I22</b>	0.4579	0.4334	<b>I32</b>	0.4461	0.4104
	0.4880	0.4611		0.4750	0.4379		0.4622	0.4150
	0.4750	0.4379		0.4622	0.4150		0.4509	0.3948
	0.4579	0.4334		0.4461	0.4104		0.4357	0.3901
<b>I11</b>	0.4605	0.4536	<b>I21</b>	0.4496	0.4308	<b>I31</b>	0.4386	0.4080
	0.4697	0.4563		0.4579	0.4334		0.4461	0.4104
	0.4579	0.4334		0.4461	0.4104		0.4357	0.3901
	0.4496	0.4308		0.4386	0.4080		0.4289	0.3877
<b>H42</b>	0.4454	0.4484	<b>H52</b>	0.4353	0.4257	<b>H62</b>	0.4251	0.4028
	0.4605	0.4536		0.4496	0.4308		0.4386	0.4080
	0.4496	0.4308		0.4386	0.4080		0.4289	0.3877
	0.4353	0.4257		0.4251	0.4028		0.4164	0.3834
<b>H41</b>	0.4302	0.4423	<b>H51</b>	0.4214	0.4200	<b>H61</b>	0.4122	0.3969
	0.4454	0.4484		0.4353	0.4257		0.4251	0.4028
	0.4353	0.4257		0.4251	0.4028		0.4164	0.3834
	0.4214	0.4200		0.4122	0.3969		0.4047	0.3779

<b>H1</b>	0.4167	0.4366	<b>H2</b>	0.4087	0.4136	<b>H3</b>	0.4007	0.3908
	0.4302	0.4423		0.4214	0.4200		0.4122	0.3969
	0.4214	0.4200		0.4122	0.3969		0.4047	0.3779
	0.4087	0.4136		0.4007	0.3908		0.3940	0.3717
<b>H11</b>	0.4045	0.4301	<b>H21</b>	0.3974	0.4072	<b>H31</b>	0.3904	0.3850
	0.4167	0.4366		0.4087	0.4136		0.4007	0.3908
	0.4087	0.4136		0.4007	0.3908		0.3940	0.3717
	0.3974	0.4072		0.3904	0.3850		0.3845	0.3659
<b>G42</b>	0.3932	0.4232	<b>G52</b>	0.3870	0.4005	<b>G62</b>	0.3812	0.3793
	0.4045	0.4301		0.3974	0.4072		0.3904	0.3850
	0.3974	0.4072		0.3904	0.3850		0.3845	0.3659
	0.3870	0.4005		0.3812	0.3793		0.3761	0.3608
<b>G41</b>	0.3800	0.4146	<b>G51</b>	0.3750	0.3923	<b>G61</b>	0.3704	0.3720
	0.3932	0.4232		0.3870	0.4005		0.3812	0.3793
	0.3870	0.4005		0.3812	0.3793		0.3761	0.3608
	0.3750	0.3923		0.3704	0.3720		0.3662	0.3536
<b>G1</b>	0.3679	0.4055	<b>G2</b>	0.3642	0.3843	<b>G3</b>	0.3608	0.3648
	0.3800	0.4146		0.3750	0.3923		0.3704	0.3720
	0.3750	0.3923		0.3704	0.3720		0.3662	0.3536
	0.3642	0.3843		0.3608	0.3648		0.3576	0.3463
<b>F4</b>	0.3482	0.3881	<b>F5</b>	0.3466	0.3698	<b>F6</b>	0.3451	0.3519
	0.3679	0.4055		0.3642	0.3843		0.3608	0.3648
	0.3642	0.3843		0.3608	0.3648		0.3576	0.3463
	0.3466	0.3698		0.3451	0.3519		0.3435	0.3335

<b>F1</b>	0.3325	0.3728	<b>F2</b>	0.3324	0.3560	<b>F3</b>	0.3323	0.3394
	0.3482	0.3881		0.3466	0.3698		0.3451	0.3519
	0.3466	0.3698		0.3451	0.3519		0.3435	0.3335
	0.3324	0.3560		0.3323	0.3394		0.3322	0.3219
<b>E4</b>	0.3218	0.3613	<b>E5</b>	0.3224	0.3456	<b>E6</b>	0.3229	0.3291
	0.3325	0.3728		0.3324	0.3560		0.3323	0.3394
	0.3324	0.3560		0.3323	0.3394		0.3322	0.3219
	0.3224	0.3456		0.3229	0.3291		0.3234	0.3129
<b>E12</b>	0.3102	0.3475	<b>E22</b>	0.3122	0.3332	<b>E32</b>	0.3142	0.3184
	0.3218	0.3613		0.3224	0.3456		0.3229	0.3291

	0.3224	0.3456		0.3229	0.3291		0.3234	0.3129
	0.3122	0.3332		0.3142	0.3184		0.3163	0.3038
<b>E11</b>	0.3020	0.3374	<b>E21</b>	0.3049	0.3232	<b>E31</b>	0.3077	0.3096
	0.3102	0.3475		0.3122	0.3332		0.3142	0.3184
	0.3122	0.3332		0.3142	0.3184		0.3163	0.3038
	0.3049	0.3232		0.3077	0.3096		0.3104	0.2960
<b>D4</b>	0.2955	0.3281	<b>D5</b>	0.2992	0.3143	<b>D6</b>	0.3025	0.3018
	0.3020	0.3374		0.3049	0.3232		0.3077	0.3096
	0.3049	0.3232		0.3077	0.3096		0.3104	0.2960
	0.2992	0.3143		0.3025	0.3018		0.3058	0.2892

<b>D1</b>	0.2902	0.3203	<b>D2</b>	0.2944	0.3070	<b>D3</b>	0.2983	0.2952
	0.2955	0.3281		0.2992	0.3143		0.3025	0.3018
	0.2992	0.3143		0.3025	0.3018		0.3058	0.2892
	0.2944	0.3070		0.2983	0.2952		0.3021	0.2833
<b>C42</b>	0.2818	0.3069	<b>C52</b>	0.2867	0.2957	<b>C62</b>	0.2916	0.2846
	0.2902	0.3203		0.2944	0.3070		0.2983	0.2952
	0.2944	0.3070		0.2983	0.2952		0.3021	0.2833
	0.2867	0.2957		0.2916	0.2846		0.2961	0.2744
<b>C41</b>	0.2761	0.2972	<b>C51</b>	0.2815	0.2868	<b>C61</b>	0.2869	0.2761
	0.2818	0.3069		0.2867	0.2957		0.2916	0.2846
	0.2867	0.2957		0.2916	0.2846		0.2961	0.2744
	0.2815	0.2868		0.2869	0.2761		0.2918	0.2665
<b>C4</b>	0.2680	0.2833	<b>C5</b>	0.2740	0.2742	<b>C6</b>	0.2805	0.2645
	0.2761	0.2972		0.2815	0.2868		0.2869	0.2761
	0.2815	0.2868		0.2869	0.2761		0.2918	0.2665
	0.2740	0.2742		0.2805	0.2645		0.2862	0.2559
<b>C8</b>	0.2562	0.2762	<b>C1</b>	0.2609	0.2706	<b>C2</b>	0.2673	0.2629
	0.2634	0.2902		0.2680	0.2833		0.2740	0.2742
	0.2680	0.2833		0.2740	0.2742		0.2805	0.2645
	0.2609	0.2706		0.2673	0.2629		0.2747	0.2540
<b>B7</b>	0.2502	0.2641	<b>B8</b>	0.2549	0.2592	<b>B9</b>	0.2618	0.2522
	0.2562	0.2762		0.2609	0.2706		0.2673	0.2629
	0.2609	0.2706		0.2673	0.2629		0.2747	0.2540
	0.2549	0.2592		0.2618	0.2522		0.2696	0.2443

■ Typical Optical/Electrical Characteristics Curves  
( $T_a=25^\circ\text{C}$  Unless Otherwise Noted )

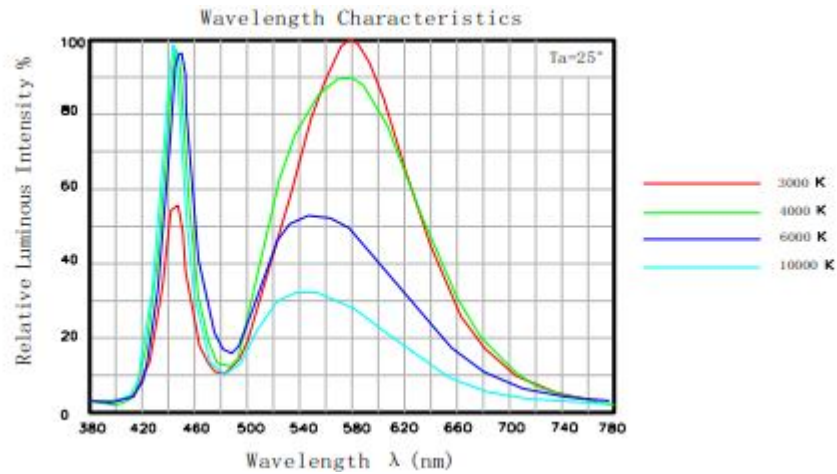
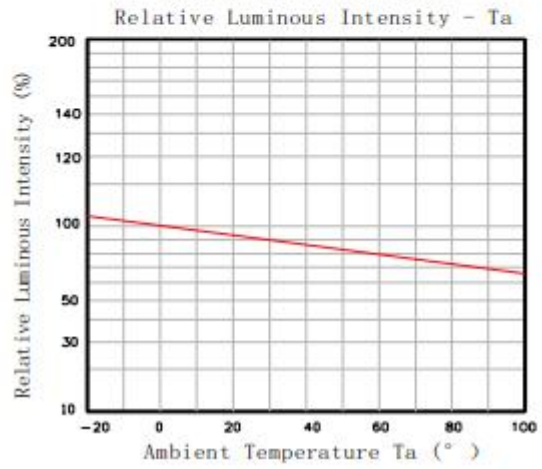
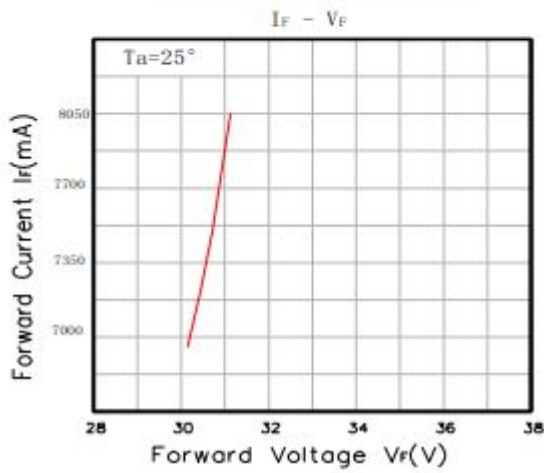
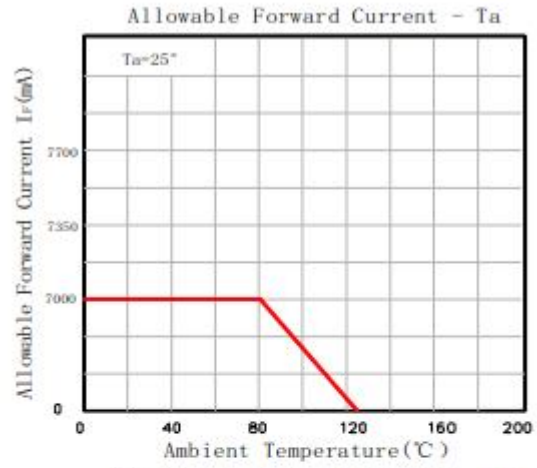
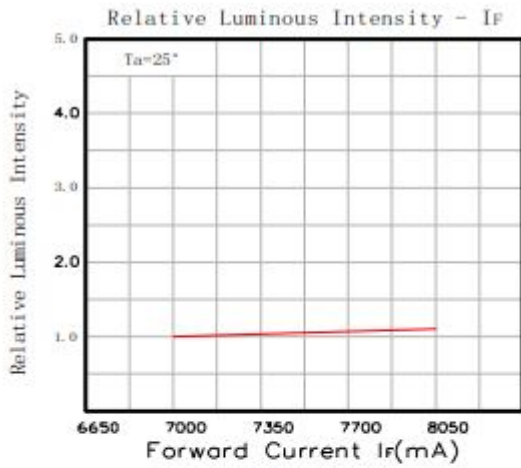



■ Reliability test standards

Type	Test Item	REF. Standard	Test condition	Duration	Sample count	Accept
	Temperature Cycle	JESD22-A104-A	-40°C~25°C~100°C~25°C 30min,5min,30min,5min	100 100 cycles	22	0/22
	Thermal shock	JESD22-A106	-40°C~100°C 30min, 30min	100 100 cycles	22	0/22
	High Temperature Storage	JEITA ED-4701 200 201	TA=100°C ± 5°C	1000 Hrs	22	0/22
	Low Temperature Storage	JEITA ED-4701 200 202	TA=-40°C ± 5°C	1000 Hrs	22	0/22
	Humidity Heat Storage	JIS C 7021 (1977)B-11	Ta=60°C RH=85%	1000Hrs	22	0/22
	Life test	JESD22-A108-A	Ta=25°C If=4550mA	1000Hrs	22	0/22
	High humidity Heat life test	JESD22-A101	Ta=60°C RH=85% IF=4550mA	1000Hrs	22	0/22
	Resistance to soldering Heat	JESD22-A113	IR soldering 245°C/10sec	1 time	20	0/22

## Precautions for use

### 1. Storage

- (1) The best Storage environment: temperature :5°C~30°C , Humidity:40% -80%HR
- (2) LED store after six months to be re-spectral color separation, to prevent the LED optical properties change

### 2. Production and application

- (1) need wear gloves when contact with led to prevent oxidation
- (2) ESD protection to be good
- (3) soldering: the pc type can use soldering iron, (the best temperature is 300°C/3sec) also can use Temperature Platform (150°C/30sec,max) the silicone type can use reflow soldering in addition to soldering iron and Temperature Platform
- (4) about Package-type silicone , It is recommended to bake before soldering when the pack is unsealed after 24h。 The conditions are as following: 80°C 4-6h。
- (5) must have a good heat sinking, the temperature of the heat sink must be below 65 degree

### 3. Relow temp/time

Solder = Low-temperature lead-free solder	Solder = Lead-free solder
Slope of the temperature rise = Max. 4°C/sec.	Slope of the temperature rise = Max. 4°C/sec.
Preheating temperature = 100°C ~ 150°C	Preheating temperature = 150°C ~ 180°C
Preheating time = Max. 60 sec.	Preheating time = Max. 90 sec.
Slope of the temperature drop = Max. 6°C/sec.	Slope of the temperature drop = Max. 6°C/sec.
Peak temperature = Max. 180°C	Peak temperature = Max. 220°C
The time of peak temperature ( $\pm 5^{\circ}\text{C}$ ) should not exceed 10 sec.	The time of peak temperature ( $\pm 5^{\circ}\text{C}$ ) should not exceed 10 sec.
The time of temperature rise of 160°C should not exceed 60 sec.	The time of temperature rise of 160°C should not exceed 60 sec.